

Submersible Motor Pump

Ama-Drainer® N 301/302/303/358

Installation/Operating Manual



Installation/Operating Manual Ama-Drainer® N 301/302/303/358
Original operating manual

KSB Aktiengesellschaft Frankenthal

All rights reserved. Contents provided herein must neither be distributed, copied, reproduced, processed for any other purpose, nor otherwise transmitted to a third party without KSB's express written consent.

Subject to technical modification without prior notice.

© KSB Aktiengesellschaft Frankenthal 04.02.2010

Contents

	Glossary	5
1	General	6
1.1	Principles	6
1.2	Symbols	6
2	Safety	7
2.1	Key to safety symbols/markings	7
2.2	General	7
2.3	Intended use	7
2.4	Personnel qualification and training	8
2.5	Consequences and risks caused by non-compliance with these operating instructions	8
2.6	Safety awareness	8
2.7	Safety instructions for the operator/user	9
2.8	Safety information for maintenance, inspection and installation work	9
2.9	Unauthorised modes of operation	9
3	Transport/Temporary Storage/Disposal	10
3.1	Transport	10
3.2	Storage and preservation	10
3.3	Disposal	10
4	Description of the Pump (Set)	11
4.1	General description	11
4.2	Designation	11
4.3	Name plate	11
4.4	Design details	12
4.5	Configuration and function	12
4.6	Scope of supply	13
5	Installation at Site	14
5.1	Safety regulations	14
5.2	Checks to be carried out prior to installation	14
5.3	Fitting the swing check valve and socket (if supplied unfitted)	14
5.4	Adjusting the cut-in level control	15
5.5	Piping	16
5.6	Installing the pump set	16
5.7	Connection to power supply	17
6	Commissioning/Start-up/Shutdown	18
6.1	Start-up/shutdown	18
6.2	Operating limits	18

6.3	Shutdown/storage/preservation	18
6.4	Returning to service after storage	18
7	Servicing/Maintenance	19
7.1	Safety regulations	19
7.2	Servicing/inspection	19
7.3	Drainage/disposal	19
7.4	Dismantling/reassembling the pump set	19
7.5	Recommended spare parts stock	19
8	Trouble-shooting	20
9	Related Documents	21
9.1	Exploded view and list of components	21
10	EC Declaration of Conformity	23
	Index	24

Glossary

Backflow

Waste water flowing back from the sewer into the connected drainage piping.

Cavitation damage

Material of the pump internals is destroyed by imploding vapour bubbles.

Flood level

Maximum backflow level of waste water in a drainage system.

Hydraulic system

The part of the pump in which the kinetic energy is converted into pressure energy

Pump

Machine without drive, additional components or accessories

Pump set

Complete pump set consisting of pump, drive, additional components and accessories

Submersible motor pump

Submersible motor pumps are floodable, close-coupled units which are not self-priming. The pumps are usually operated completely submerged. They may be operated outside the fluid for short periods of time, until the minimum fluid level has been reached.

Waste water

Water consisting of a combination of water discharged from households, industrial and other businesses as well as surface water.

1 General

1.1 Principles

This manual is supplied as an integral part of the type series indicated on the front cover. It describes the proper and safe use of this equipment in all phases of operation.

The name plate indicates the type series, the main operating data, the order number and the order item number. The order number and order item number clearly identify the pump and serve as identification for all further business processes.

In the event of damage, immediately contact your nearest KSB service centre to maintain the right to claim under warranty.

1.2 Symbols

Table 1: Symbols used in this manual

Symbol	Description
✓	Conditions which need to be fulfilled before proceeding with the step-by-step instructions
▷	Safety instructions
⇒	Result of an action
⇔	Cross-references
1. 2.	Step-by-step instructions
	Note Recommendations and important information on how to handle the product







2 Safety



All the information contained in this section refers to hazardous situations.

2.1 Key to safety symbols/markings

Table 2: Definition of safety symbols/markings

Symbol	Description
 DANGER	DANGER This signal word indicates a high-risk situation which, if not avoided, will result in death or serious injury.
 WARNING	WARNING This signal word indicates a medium-risk situation which, if not avoided, could result in death or serious injury.
 CAUTION	CAUTION This signal word indicates a hazardous situation which, if not avoided, could damage the machine and its functions.
	General hazard In conjunction with one of the signal words this symbol indicates a hazard which will or could result in death or serious injury.
	Electrical hazard In conjunction with one of the signal words this symbol indicates a hazard involving electrical voltages and provides information about protection against electrical voltages.
	Machine damage In conjunction with the signal word CAUTION this symbol indicates a hazardous situation for the machine and its functions.

2.2 General

This manual contains general installation, operating and maintenance instructions that must be observed to ensure safe pump operation and prevent personal injury and damage to property.

The safety information in all sections of this manual must be complied with.

This manual must be read and completely understood by the responsible specialist personnel/operators prior to installation and commissioning.

The contents of this manual must be available to the specialist personnel at the site at all times.

Information attached directly to the pump must always be complied with and be kept in a perfectly legible condition at all times. This applies to, for example:

- Arrow indicating the direction of rotation
- Markings for connections
- Name plate

The operator is responsible for ensuring compliance with all local regulations which are not taken into account in this manual.

2.3 Intended use

The pump (set) must only be operated within the operating limits which are described in the other applicable documents.

- Only operate pumps/pump sets which are in perfect technical condition.
- Do not operate partially assembled pumps/pump sets.
- Only use the pump to handle the fluids specified in the data sheet or product literature of the respective design variant.
- Never operate the pump without the fluid to be handled.

- Observe the minimum flow rates indicated in the data sheet or product literature (to prevent overheating, bearing damage, etc).
- Observe the maximum flow rates indicated in the data sheet or product literature (to prevent overheating, mechanical seal damage, cavitation damage, bearing damage, etc).
- Do not throttle the flow rate on the suction side of the pump (to prevent cavitation damage).
- Consult the manufacturer about any use or mode of operation not described in the data sheet or product literature.

Prevention of foreseeable misuse

- Never open discharge-side shut-off elements further than permitted.
 - The maximum flow rate specified in the data sheet or product literature would be exceeded.
 - Risk of cavitation damage
- Never exceed the permissible operating limits specified in the data sheet or product literature regarding pressure, temperature, etc.
- Observe all safety information and instructions in this manual.

2.4 Personnel qualification and training

All personnel involved must be fully qualified to install, operate, maintain and inspect the machinery this manual refers to.

The responsibilities, competence and supervision of all personnel involved in installation, operation, maintenance and inspection must be clearly defined by the operator.

Deficits in knowledge must be rectified by sufficiently trained specialist personnel training and instructing the personnel who will carry out the respective tasks. If required, the operator can commission the manufacturer/supplier to train the personnel.

Training on the pump (set) must always be supervised by technical specialist personnel.

2.5 Consequences and risks caused by non-compliance with these operating instructions

- Non-compliance with these operating instructions will lead to forfeiture of warranty cover and of any and all rights to claims for damages.
- Non-compliance can, for example, have the following consequences:
 - Hazards to persons due to electrical, thermal, mechanical and chemical effects and explosions
 - Failure of important product functions
 - Failure of prescribed maintenance and servicing practices
 - Hazard to the environment due to leakage of hazardous substances

2.6 Safety awareness

In addition to the safety information contained in this manual and the intended use, the following safety regulations shall be complied with:

- Accident prevention, health and safety regulations
- Explosion protection regulations
- Safety regulations for handling hazardous substances
- Applicable standards and laws

2.7 Safety instructions for the operator/user

- Fit contact guards supplied by the operator for hot, cold or moving parts, and check that the guards function properly.
- Do not remove the contact guards while the pump is running.
- Provide the personnel with protective equipment and make sure it is used.
- Contain leakages (e.g. at the shaft seal) of hazardous fluids handled (e.g. explosive, toxic, hot) so as to avoid any danger to persons and the environment. Adhere to all relevant laws.
- Eliminate all electrical hazards. (In this respect refer to the applicable national safety regulations and/or regulations issued by the local energy supply companies.)
- Prevent the pump set from being accessed by small children or fragile persons without supervision.
Children must not play with the pump set.

2.8 Safety information for maintenance, inspection and installation work

- Modifications or alterations of the pump are only permitted with the manufacturer's prior consent.
- Use only original spare parts or parts authorised by the manufacturer. The use of other parts can invalidate any liability of the manufacturer for consequential damage.
- The operator ensures that all maintenance, inspection and installation work is performed by authorised, qualified specialist personnel who are thoroughly familiar with the manual.
- Carry out work on the pump (set) during standstill only.
- The pump casing must have cooled down to ambient temperature.
- Pump pressure must have been released and the pump must have been drained.
- When taking the pump set out of service always adhere to the procedure described in the manual.
- Decontaminate pumps which handle fluids posing a health hazard.
- As soon as the work is completed, re-install and/or re-activate any safety-relevant and protective devices. Before returning the product to service, observe all instructions on commissioning.

2.9 Unauthorised modes of operation

Never operate the pump (set) outside the limits stated in the data sheet and in this manual.

The warranty relating to the operating reliability and safety of the supplied pump (set) is only valid if the equipment is used in accordance with its intended use. (⇒ Section 2.3 Page 7)

3 Transport/Temporary Storage/Disposal

3.1 Transport

	CAUTION
	<p>Improper pump transport Damage to the pump!</p> <ul style="list-style-type: none"> ▷ To transport the pump/pump set always use the handle provided. ▷ Never suspend the pump (set) from the float switch (only type SE) or the power supply cable for transport. ▷ Prevent the pump (set) from getting knocked or dropped.

3.2 Storage and preservation

	CAUTION
	<p>Damage during storage by frost, humidity, dirt, UV radiation or vermin Corrosion/contamination of the pump!</p> <ul style="list-style-type: none"> ▷ Store the pump (set) in a frost-free and roofed area.

Store the pump (set) vertically in a dry, dark, frost-proof room not exposed to sunlight. Under these conditions it does not need additional preservation.

3.3 Disposal

	⚠ WARNING
	<p>Fluids posing a health hazard Hazardous to persons and the environment!</p> <ul style="list-style-type: none"> ▷ Collect and properly dispose of flushing liquid and any fluid residues. ▷ Wear safety clothing and a protective mask, if required. ▷ Observe all legal regulations on the disposal of fluids posing a health hazard.

1. Dismantle the pump (set).
Collect greases and other lubricants during dismantling.
2. Separate and sort the pump materials, e.g. by:
 - Metals
 - Plastics
 - Electronic waste
 - Greases and other lubricants
3. Dispose of materials in accordance with local regulations or in another controlled manner.

4 Description of the Pump (Set)

4.1 General description

Standard model

	CAUTION
	<p>Unsuitable fluids Damage to the pump!</p> <ul style="list-style-type: none"> ▷ Never use the pump to handle corrosive, combustible or explosive fluids. ▷ Never use the pump to handle waste water. ▷ Do not use the pump for foodstuff applications.

- Submersible motor pump

Pump for handling seepage water

Suitable for handling chemically neutral, slightly contaminated waste water as well as wash water.

Table 3: Particle size for slightly contaminated waste water

Type series	Maximum particle size [mm]
Ama®-Drainer N 301/302/303	10
Ama®-Drainer N 358	35

Variant C

Suitable fluids as above and, in addition:

- Sea water

4.2 Designation

Example: Ama-Drainer® N 302 SE/NE/C

Table 4: Key to the designation

Code	Description
Ama-Drainer® N 302	Type series
S	With float switch
N	Without float switch
E	Motor version, e.g. E = single-phase a.c. motor
C	Variant for aggressive water

4.3 Name plate

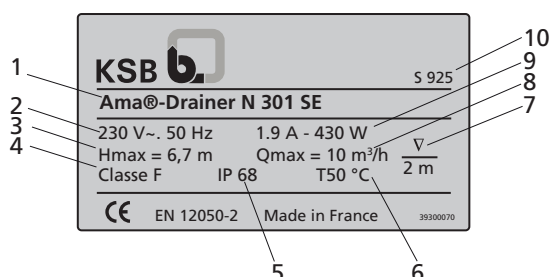

Fig. 1: Name plate

1	Type series, pump size	2	Rated voltage/frequency
3	Maximum head	4	Thermal class of winding insulation
5	Enclosure	6	Maximum fluid and ambient temperature

7	Maximum immersion depth	8	Maximum flow rate
9	Rated power	10	Serial number S = series, 9 = year of construction 2009, 25 = week 25

4.4 Design details

Design

All parts which will come into contact with the fluid handled are made of rust-proof materials.

- Vertical installation
- Single-stage
- Meets all requirements laid down in EN 12050-2

Motor

- Single-phase a.c. motor (230 V)
- Cooled by the fluid handled
- Thermal motor protection with automatic reset and start-up
- Earthed power supply cable

Pump casing

- Annular casing

Impeller type

- Free-flow impeller

Bearings

- Enclosed bearings, grease-packed for life

4.5 Configuration and function

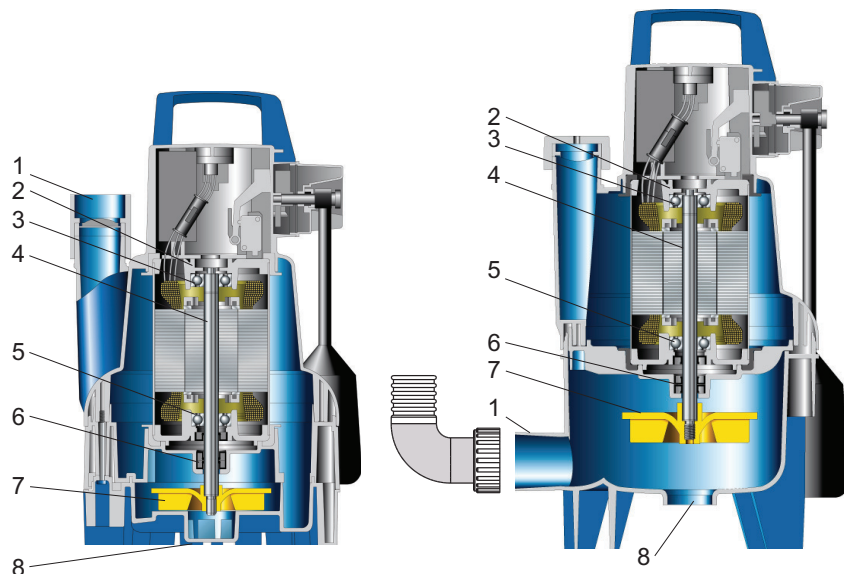

Fig. 2: Sectional drawing

1	Discharge nozzle Optional: with hose connection	2	Bearing bracket
3	Rolling element bearing	4	Shaft
5	Rolling element bearing	6	Shaft seal
7	Impeller	8	Foot opening

Design The pump is designed with an axial fluid inlet and an outlet parallel to the axis, pointing upwards. (The outlet of Ama®-Drainer N 358 pumps is horizontal,

perpendicular to the axis.) The hydraulic system runs in its own bearings and is connected to the motor by a shaft coupling.

- Function** The fluid enters the pump via an opening in the foot (8) and is accelerated outwards in a cylindrical flow by the rotating impeller (7). The flow profile of the pump casing converts the kinetic energy of the fluid into pressure energy. The fluid is pumped to the discharge nozzle (1), where it leaves the pump. At the rear side of the impeller, the shaft (4) enters the casing via the casing wall. The shaft passage through the cover is sealed towards the atmosphere with a shaft seal (6). The shaft runs in rolling element bearings (3 and 5), which are supported by a bearing bracket (2). The bearing bracket is linked with the pump casing and/or casing cover.
- Sealing** The pump is sealed by three bi-rotational shaft seals in tandem arrangement. A lubricant reservoir between the seals ensures cooling and lubrication of the shaft seals.

4.6 Scope of supply



Depending on the model, the following items are included in the scope of supply:

- Pump set
- Non-return valve
- Connection socket with internal thread
- Locking disc for float
- Cable (3 metres or 10 metres)

Special accessories Further (special) accessories can be ordered through your distributor.

5 Installation at Site

5.1 Safety regulations

	<p>⚠ DANGER</p> <p>Unsuitable electrical installation Danger to life!</p> <ul style="list-style-type: none"> ▷ Make sure the electrical installation meets the VDE 0100 installation rules (i.e. sockets with earthing terminals). ▷ Make sure the electric mains is equipped with a residual current device of maximum 30 mA. ▷ If in doubt, contact a specialist electrical company.
	<p>⚠ DANGER</p> <p>Pump used outdoors Danger of death from electric shock!</p> <ul style="list-style-type: none"> ▷ Do not use models with 3-metre cable length outside of buildings. ▷ Any extension cords must match the quality of the supplied pump cable (10-metre cable length). ▷ Do not expose electrical connections to any moisture.
	<p>⚠ DANGER</p> <p>Continuous pump operation in swimming pools, garden ponds or similar Danger of death from electric shock!</p> <ul style="list-style-type: none"> ▷ Make sure that nobody is in the water while the pump is in operation. ▷ Only use the pump for draining swimming pools, garden ponds, etc. (It is impermissible to use this pump as a recirculation pump, for example.)

5.2 Checks to be carried out prior to installation

Before installing the pump make sure that the following requirements are met:

- Check the data on the name plate of the pump to make sure it can be operated on the available mains.
- The fluid to be handled matches the description of suitable fluids.
- The above safety instructions have been complied with.

5.3 Fitting the swing check valve and socket (if supplied unfitted)

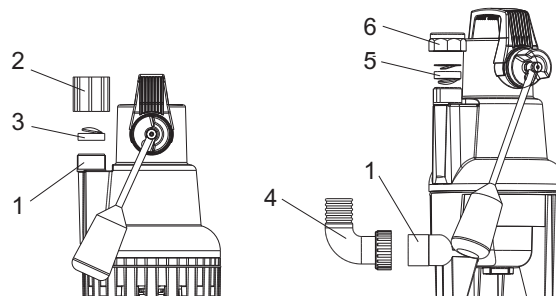

Ama®-Drainer N 301/302/303

Ama®-Drainer N 358

Fig. 3: Fitting the swing check valve and socket

1	Discharge nozzle	2	Socket 1 1/4"
3	Swing check valve	4	Hose connection 1 1/2"
5	Suction valve	6	Screwed plug

1. Position the swing check valve on the discharge nozzle.
For Ama®-Drainer N 301/302/303: Make sure the disc of the swing check valve opens upwards.
For Ama®-Drainer N 358: Make sure the disc of the swing check valve opens downwards.
2. Screw the socket on with the long thread and tighten it.

5.4 Adjusting the cut-in level control

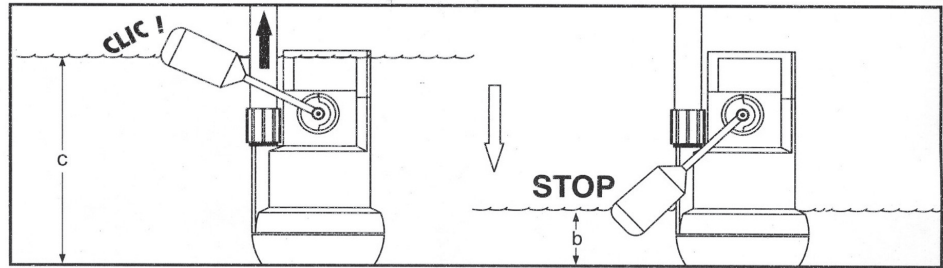

Fig. 4: Cut-in/Cut-out levels

Table 5: Limits of the float levels

Type series	b min	b max
Ama®-Drainer N 301 SE	~ 70 mm	~ 295 mm
Ama®-Drainer N 302 SE	~ 110 mm	~ 315 mm
Ama®-Drainer N 303 SE	~ 110 mm	~ 315 mm
Ama®-Drainer N 358 SE	~ 110 mm	~ 395 mm

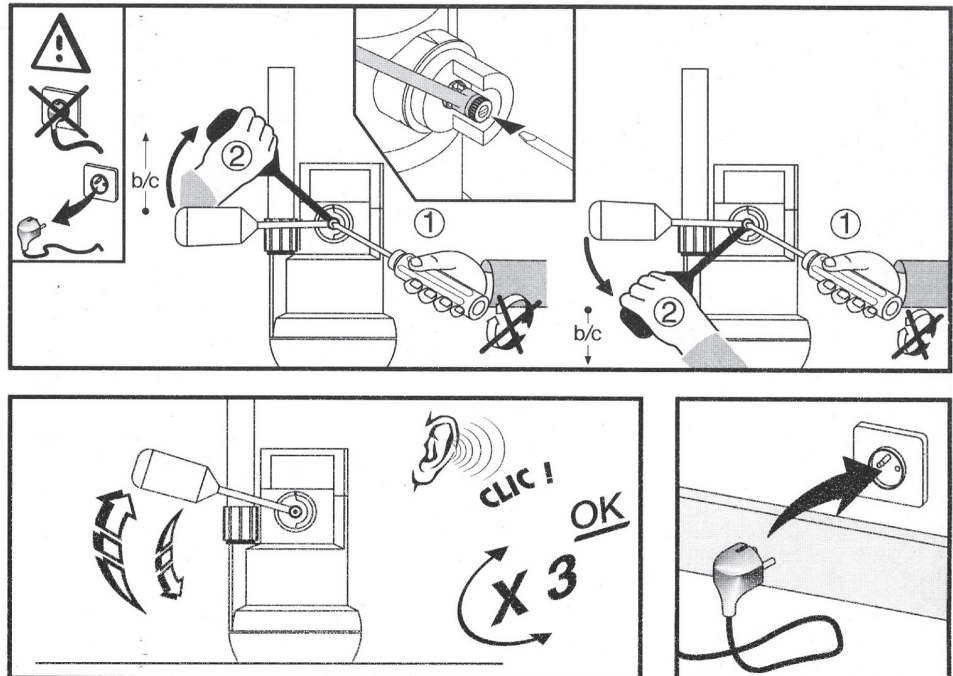

Fig. 5: Adjusting the cut-in level control

1. Unplug the pump set.
2. Insert a screwdriver into the screw at the float and hold it in this position.
Do not turn the screw.
3. Push the float up or down to adjust it to the required cut-in level.

4. Pull the screwdriver back out again.
5. Check the cut-in level by moving the float up and down. You should be able to hear a "click" each time the float is lifted up to the cut-in level.
6. Plug the pump back into the mains.

5.5 Piping

5.5.1 Connecting the piping (stationary installation – 3 metre cable length)

	NOTE
The highest point of the discharge line must be above the flood level (usually street level) to prevent any backflow from the sewage system.	

Ama®-Drainer N 301/302/303

1. Connect the pump and piping at the G 1 ¼ thread of the discharge nozzle. Use a pipeline with an inner diameter of 32 millimetres.

Ama®-Drainer N 358

1. Connect the pump and piping at the G 1 ½ thread tangential discharge nozzle of the suction cover. Use a pipeline with an inner diameter of 40 millimetres.

5.5.2 Connecting the piping (transportable installation – 10 metre cable length)

Ama®-Drainer N 301/302/303

1. A hose with an inner diameter of 30 millimetres can be connected to the pump set. To do so, screw a G 1 ¼ adaptor into the threaded socket (see accessories "drainage hose set A 25 B").
2. Fasten the hose with a hose clip.

Ama®-Drainer N 358

1. Screw on the G 1 ½" adaptor for a hose of 40 millimetres inner diameter (an elbow is available as an option).
2. Fasten the hose with a hose clip.

5.6 Installing the pump set

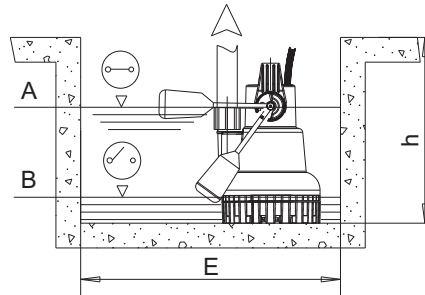

Fig. 6: Installation dimensions

A	Cut-in level	B	Cut-out level
---	--------------	---	---------------

Table 6: Recommended installation dimensions

Type series	E [mm]	h [mm]
Ama®-Drainer N 301	400 x 400	400
Ama®-Drainer N 302/303	400 x 400	500
Ama®-Drainer N 358	400 x 450	550

1. For transporting and lifting the pump observe the following notes. (⇒ Section 3.1 Page 10)

2. If required, suspend the pump using a rope attached to the handle.
3. Place the pump on a solid surface.
Recommended installation dimensions 400 x 400 mm (400 x 450 mm for Ama®-Drainer N 358)
4. Make sure that the float can move freely.

5.7 Connection to power supply

Plug the pump into the mains socket.

The pump switches on and off automatically.

6 Commissioning/Start-up/Shutdown

6.1 Start-up/shutdown

The pump's automatic control system will cut in when level "A" is reached and will cut out when level "B" is reached (⇒ Section 5.6 Page 16)

6.2 Operating limits

Table 7: Operating limits

Characteristic	Ama®-Drainer N 301	Ama®-Drainer N 302	Ama®-Drainer N 303	Ama®-Drainer N 358
Head	max. 6.5 m	max. 10 m	max. 12.5 m	max. 8.5 m
Flow rate	max. 10 m³/h	max. 12 m³/h	max. 14 m³/h	max. 16.5 m³/h
Immersion depth	max. 2 m	max. 2 m	max. 2 m	max. 2 m
Voltage/Frequency	230 V/50 Hz	230 V/50 Hz	230 V/50 Hz	230 V/50 Hz
Max. temperature, continuous	0 to 50 °C	0 to 50 °C	0 to 50 °C	0 to 35 °C
Particle size (maximum diameter)	10 mm	10 mm	10 mm	35 mm
Residual water level (Type NE for manual operation)	min. 15 mm	min. 15 mm	min. 15 mm	min. 37 mm
Power input	max. 180 W	max. 356 W	max. 500 W	max. 430 W
Enclosure	IP 68	IP 68	IP 68	IP 68
Power supply cable		10 m H07RN8-F	10 m H07RN8-F	10 m H07RN8-F
	Type SE	3 m H05RN8-F	3 m H05RN8-F	3 m H05RN8-F
				--

6.3 Shutdown/storage/preservation

6.3.1 Measures to be taken for shutdown

1. Unplug the pump set.
2. Wait for the pump to cool down (at least 10 minutes) before removing it from the tank.
3. Separate the pump from the discharge line.
4. Unscrew the connection socket at the discharge nozzle and remove the swing check valve.
5. Clean the pump and its add-on parts under a water jet.
 - Point the water jet into the discharge nozzle.
 - For Ama®-Drainer N 358: Unscrew the plug of the venting and cleaning system. Remove the swing check valve and point the water jet into the opening.
6. Allow the parts to dry.
7. Re-install the connection socket and the swing check valve. Observe the assembly sequence.
8. Store the pump vertically in a dry, dark and frost-proof room.



	NOTE
	Special preservation measures are not required.

6.4 Returning to service after storage

(⇒ Section 5 Page 14)

7 Servicing/Maintenance

7.1 Safety regulations

	<p>⚠ DANGER</p> <p>Power supply not disconnected Danger to life!</p> <ul style="list-style-type: none"> ▷ Pull the mains plug and secure the pump against accidental start-up.
	<p>⚠ DANGER</p> <p>Work on the pump set by unqualified personnel Danger of death from electric shock!</p> <ul style="list-style-type: none"> ▷ Have pump components modified and dismantled by authorised personnel only.

7.2 Servicing/inspection

The pump is practically maintenance-free.

It will suffice to regularly clean the pump set and carry out visual inspections of the condition of the pump set and discharge line.

7.3 Drainage/disposal

The pump will be automatically drained when it is taken out of the fluid handled.

7.4 Dismantling/reassembling the pump set

7.4.1 General notes/Safety regulations

Dismantling/reassembly work must be effected by authorised specialist personnel only.

	<p>NOTE</p> <p>All maintenance, service and installation work can be carried out by KSB Service. Find your contact in the attached "Addresses" booklet or on the Internet at www.ksb.com/contact".</p>
---	--

7.5 Recommended spare parts stock

Keeping a spare parts stock is not recommended.

8 Trouble-shooting

Table 8: Trouble-shooting

Fault/malfunction	Cause	Remedy ¹⁾
Pump is running, but does not or hardly deliver.	The hydraulic system is clogged by foreign matter.	Clean the hydraulic system with a water jet. (⇒ Section 6.3 Page 18)
	The discharge line is closed.	Open all accessories fitted at the discharge line.
	The non-return valve has been fitted for the opposite direction of flow or is clogged.	Reassemble observing the correct sequence (⇒ Section 9.1 Page 21) or clean the non-return valve.
The pump is not running or only for a short time.	The thermal motor protection device triggers because:	
	1) Pump overheating	Check the fluid temperature.
	2) Pump running dry	Verify the minimum fluid level.
	The power supply is interrupted	Check the electrical installation.

¹⁾ Pump pressure must be released before attempting to remedy faults on parts which are subjected to pressure. Disconnect the pump from the power supply and allow it to cool down.

9 Related Documents

9.1 Exploded view and list of components

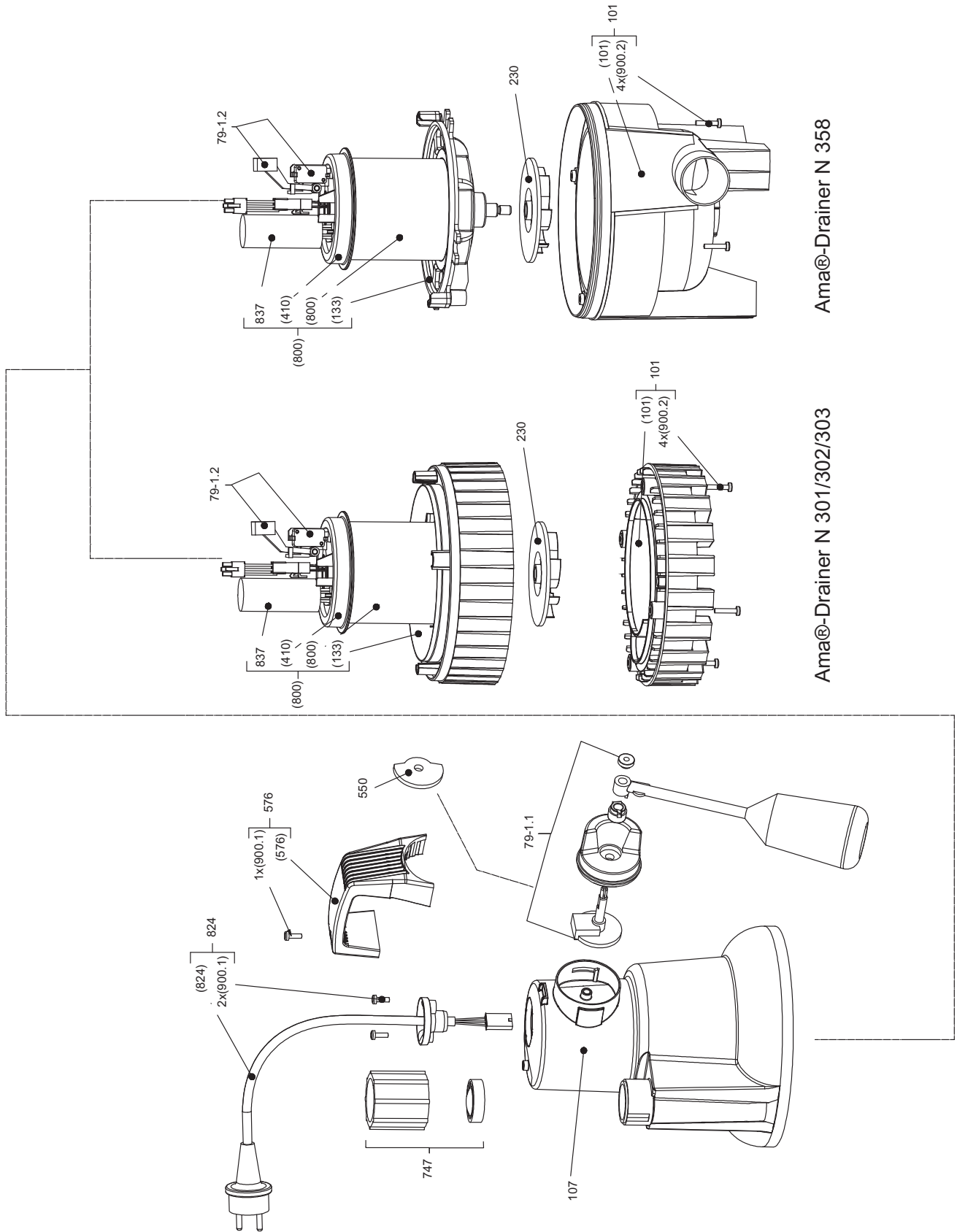

Ama®-Drainer N 358

Ama®-Drainer N 301/302/303

Fig. 7: Ama®-Drainer N – Exploded view

Table 9: List of components

Part No.	Description
101	Pump casing
107	Discharge casing
230	Impeller
550	Locking disc for float
576	Handle
747	Swing check valve and cleaning hole
79-1.1	Automatic switch (external)
800	Motor
824	Cable

10 EC Declaration of Conformity

Manufacturer:

KSB S.A.S.
128, rue Carnot,
59320 Sequedin/Lille (France)

The manufacturer herewith declares that **the pump/pump set:**

Ama-Drainer® N 301/302/303/358

Series number: S 1001 - S 1452

- is in conformity with the provisions of the following directives as applicable in their current version:
 - EC Machinery Directive 2006/42/EC
- Applied harmonised standards
 - ISO 12100-1/A1, ISO 12100-2/A1,
 - ISO 14121-1,
 - EN 809/A1,
 - EN 60034-1, EN 60034-5/A1,
 - EN 60335-1/A1, EN 60335-2-41/A1

Frankenthal, 29.12.2009



Frank Mewes
Head of Product Group Management Submersible Motor Pumps
Responsible for compiling the technical documentation
KSB Aktiengesellschaft
Johann-Klein-Straße 9
67227 Frankenthal

Index

B

Bearings 12

C

Commissioning 18

D

Design 12

Designation 11

Disposal 10

E

Exploded view 21

F

Fault/malfunction 20

I

Impeller type 12

Intended use 7

M

Misuse 8

N

Name plate 11

O

Operating limits 7

P

Product description 11

S

Safety 7

Safety awareness 8

Scope of supply 13

Shutdown 18

Start-up 18

T

Transport 10



KSB Aktiengesellschaft

P.O. Box 1361 • 91253 Pegnitz • Bahnhofplatz 1, 91257 Pegnitz (Germany)

Tel. +49 9241 71-0 • Fax +49 9241 71-1793

www.ksb.com